



# FIBRE FRAME

## **BRACKETS, FASTENERS & END CAPS**

GRP AUSTRALIA | 2025

GRP-GU-08-REV01



FIBRE FRAME BRACKETS, FASTENERS & END CAPS 2025

# CONTENTS

PAGE  
NUMBER

1.0	<b>INTRODUCTION</b>	3
2.0	<b>DISCLAIMER</b>	3
3.0	<b>CODES &amp; STANDARDS</b>	4
4.0	<b>CORROSION PROTECTION</b>	4
5.0	<b>INSTALLATIONS REQUIREMENTS</b>	4
6.0	<b>CONNECTORS, FASTENERS &amp; END CAPS</b>	5
	6.1 Fasteners	7
	6.2 Joist Hanger Brackets	8
	6.3 Triple Grips	9
	6.4 Bearer to Post Brackets	10
	6.4.1 Post Top Brackets	11
	6.4.2 Post Side Brackets	12
	6.5 Angle Bracket	13
	6.6 Pergola Brackets	14
	6.7 Splice Plates	15
	6.8 Post Supports	16
	6.9 End Caps	17
	6.10 Adjustable Pedestals	18

## 1.0 INTRODUCTION

The Fibre Frame substructure framing system by GRP Australia offers a robust structural solution ideal for challenging environments like poolside decks, marine environments, low-ground decks, and various outdoor spaces. Fibre Frame is long-lasting, resistant to decay and termite damage, non-corrosive, lightweight, and simple to install.

This product guide explains the Fibre Frame brackets and fasteners that are specially designed for use with Fibre Frame bearers, joists and posts. The brackets and fasteners are made from marine grade stainless steel to ensure the Fibre Frame system will endure even in the most extreme conditions.

This product guide is based on the following:

- » **No Substitution:** The framing connectors and fasteners are used with GRP Australia Fibre Frame GRP structural members.
- » **Installation:** the installation of the Fibre Frame products must be in accordance with this document & *GRP-GU-07 - Load & Span Guide*
- » **Current Product Design Guide:** Designers and users should check the GRP Australia website [GRPAustralia.com.au](http://GRPAustralia.com.au), to ensure they are using the most up to date revision of this product design guide.

## 2.0 DISCLAIMER

The information provided in this catalogue has been carefully calculated to the best of our ability. However, it is the responsibility of a qualified professional to interpret and apply this data in accordance with project-specific requirements. GRP Australia accepts no liability for any misuse or misinterpretation of the data contained within this catalogue. For assistance with product selection or if you have any uncertainties, please consult GRP Australia directly to ensure appropriate use of our products

### 3.0 CODES & STANDARDS

The Fibre Frame structural framing system has undergone extensive testing to meet Australian Standards, ensuring both quality and safety. These standards include:

**AS 1170.0:2002** - Structural design actions - Part 0: General principles

**AS/NZS 1170.1:2002** - Structural design actions - Part 1: Permanent, imposed and other actions

**AS/NZS 1170.2:2011** - Structural design actions - Part 2: Wind actions

**ANSI/ACMA** - Pre-Standard for Load & Resistance Factor Design (LRFD) of Pultruded Fibre Reinforced Polymer (FRP) Structures

### 4.0 CORROSION PROTECTION

All brackets and connections are constructed from marine-grade 316 stainless steel. This coupled with bearers, joists and posts made from GRP result in a structural framing system that will not corrode, rot or be eaten by termites.

### 5.0 INSTALLATION REQUIREMENTS

The following outlines some basic requirements for the correct installation of the Fibre Frame system:

- » Joint gaps between GRP Fibre Frame system must be no greater than 3mm.
- » Fasteners must be the Marine Grade Fibre Frame 10Gx25 G410 Rustpert Treated or approved equivalent.
- » It is important to avoid over tightening fasteners. Testing and adjusting the driver torque settings before starting assembly is highly recommended.

## 6.0 CONNECTORS, FASTENERS & END CAPS

The table below lists the Fibre Frame brackets and fasteners, all made from marine grade 316 Stainless Steel.

### BRACKETS & FASTENERS







PRODUCT CODE	DESCRIPTION	PAGE	PRODUCT CODE	DESCRIPTION	PAGE
 10Gx25 G SDS	<b>Fasteners</b> Self drilling Marine grade fastener 25m long with No 2 Square drive.	6	 FFPSB10045	<b>100mm Post Side Bracket (45mm Bearer)</b> Suitable for 100 post and 45mm wide bearer	11
 FFAB10040	<b>Angle Bracket 100x40x2</b> Versatile angel bracket for use with 10G screws.	12	 FFPTB76	<b>76mm Post Top Bracket</b> Suitable for 76mm Posts connecting to all Fibre Frame Bearers	10
 FFHB4590	<b>Joist Hanger 45 - 90</b> Suitable for Fibre Frame joists FF9045 and FF12045.	7	 FFPTB100	<b>100mm Post Top Bracket</b> Suitable for 100mm Posts connecting to all Fibre Frame Bearers	10
 FFHB45140	<b>Joist Hanger 45-140</b> Suitable for Fibre Frame joists FF14045	7	 FFSP190100	<b>Splice Plate 190 x 100 x 1.5mm thick.</b> Extension of bearers and for use with FFPTB100 and FFPTB76 to increase load bearing capacity.	14
 FFPB01	<b>Pergola Bracket</b> 86x65x36x1.5	13	 FFTGLH	<b>Tripe Grip</b> Left Hand	8
 FFPSB10050	<b>100mm Post Side Bracket (50mm Bearer)</b> Suitable for 100 post and 50mm wide bearer.	11	 FFTGRH	<b>Tripe Grip</b> Right Hand	8

# FIBRE FRAME







## BRACKETS, FASTENERS & END CAPS

6

### END CAPS

PRODUCT CODE	DESCRIPTION	PAGE	PRODUCT CODE	DESCRIPTION	PAGE
 EC9045	End Cap 90x45 for use on FF9045.	16	 EC20050	End Cap 200x50 for use on FF20050	16
 EC12045	End Cap 120x45 for use on FF12045.	16	 EC7676	End Cap 76x76	16
 EC14045	End Cap 140x45 for use on FF14045	16	 EC100100	End Cap 100x100	16

### ADJUSTABLE PEDESTALS

PRODUCT CODE	DESCRIPTION	PAGE	PRODUCT CODE	DESCRIPTION	PAGE
 GP50	Adjustable Pedestal (50mm-75mm)	16	 GP197	Adjustable Pedestal (197mm-281mm)	16
 GP74	Adjustable Pedestal (74mm-117mm)	16	 GP277	Adjustable Pedestal (277mm-446mm)	16
 GP117	Adjustable Pedestal (117mm-201mm)	16	 GPJH	Pedestal Joist Holder	16

## 6.1 FASTENERS

The Fibre Frame brackets and connectors have been designed for use with the Fibre Frame self-drilling screw 10Gx25 G316ss Wafer Head Screws



Screw Design Capacity		
GRP Member Wall Thickness (mm)	Design Shear Capacity $\lambda\Phi V_n$ (kN)*	Design Pullout Capacity $\lambda\Phi N_n$ (kN)*
4	1.6	0.4
5	1.96	0.6
6		0.9
8		1.0

*The Capacity is calculated according to the ANSI/ACMA section 2.3.2 & AS1170.0 Appendix B*

# FIBRE FRAME

## BRACKETS, FASTENERS & END CAPS

8

### 6.2 JOIST HANGER BRACKETS



FFHB4590



FFHB45140



#### Brackets

Product	Material	Thickness (mm)	Width (mm)	Height (mm)
FFHB4590	316ss	1	46	78
FFHB45140	316ss	1	46	134

#### Hanger Bracket Design Capacity

Product	Suitable for FF Joist/Bearer	Screw QTY	Design Capacity $\lambda\Phi V_n$ (kN)	Uplift Capacity $\lambda\Phi V_n$ (kN)
FFHB4590	FF9045	8 - In Bearer 6 - In Joist 1 - On Underside	6.5	10
FFHB4590	FF12045	8 - In Bearer 6 - In Joist 1 - On Underside	6.5	
FFHB45140	FF14045	8 - In Bearer 6 - In Joist 1 - On Underside	8.7	10



## 6.3 TRIPLE GRIPS

Triple grips are used in the Fibre Frame structural framing system to secure the joists to the top of bearers.



FFTGLH



FFTGRH

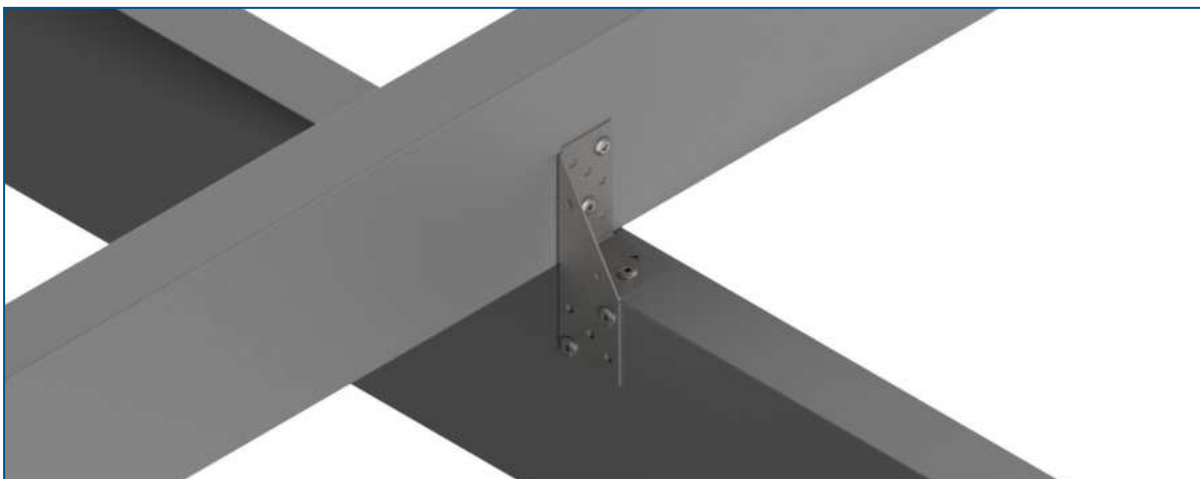

### Brackets

Product	Material	Screw QTY	Thickness (mm)	Width (mm)	Height (mm)
FFTGLH	316ss	2 - Joist 1 - Top of Bearer 2 - Side of Bearer	1	36	118
FFTGRH	316ss	2 - Joist 1 - Top of Bearer 2 - Side of Bearer	1	36	118

# FIBRE FRAME

## BRACKETS, FASTENERS & END CAPS

10

### 6.4 BEARER TO POST BRACKETS

The Fibre Frame system offers two types of brackets for connecting bearers to posts. The post top bracket and the post side bracket.

#### 6.4.1 POST TOP BRACKETS

The images below show a typical post-top bracket connection. For heavy loads, a splice plate is needed inside the bracket.



FFPTB100



FFPTB76



Brackets

Product	Material	Thickness (mm)	Width (mm)	Height (mm)
FFPTB100	316ss	1.5	103.5	147
FFPTB76	316ss	1.5	79.5	137



### Post Top Bracket Design Capacity Without Splice Plate

Product	Suitable for FF Joist/Bearer	Screw QTY	Design Capacity $\lambda\Phi V_n$ (kN)	Uplift Capacity $\lambda\Phi V_n$ (kN)
FFPTB100	FF12045	6 - In Bearer 6 - In Post, 3 either side	16	10
	FF14045		17.4	
	FF20050		18.8	
FFPTB76	FF12045	6 - In Bearer 6 - In Post, 3 either side	15	10
	FF14045		15	

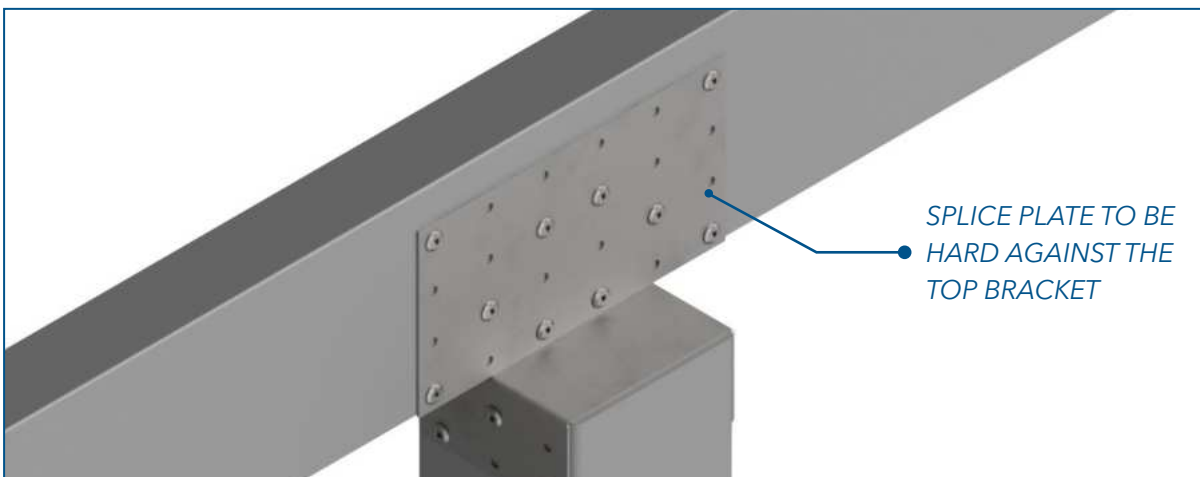

### Post Top Bracket Design Capacity With Splice Plate

Product	Suitable for FF Joist/Bearer	Screw QTY	Design Capacity $\lambda\Phi V_n$ (kN)	Uplift Capacity $\lambda\Phi V_n$ (kN)
FFPTB100	FF12045	6 - In Bearer 6 - In Post, 3 either side 10 - In Splice Plate	24.4	10
	FF14045		29	
	FF20050		34.4	
FFPTB76	FF12045	6 - In Bearer 6 - In Post, 3 either side 10 - In Splice Plate	24.4	10
	FF14045		28	

# FIBRE FRAME

## BRACKETS, FASTENERS & END CAPS

12

### 6.4.2 POST SIDE BRACKETS

The image below illustrates a standard bearer to post connection using a post side bracket.



FFPSB10050



FFPSB10045



#### Brackets

Product	Material	Thickness (mm)	Width (mm)	Height (mm)
FFPSB10050	316ss	1.5	100	190
FFPSB10045	316ss	1.5	100	112

#### Design Capacity of Post Side Brackets

Product	Suitable for FF Joist/Bearer	Screw QTY	Design Capacity $\lambda\Phi V_n$ (kN)	Uplift Capacity $\lambda\Phi V_n$ (kN)
FFPSB10050	FF20050	12 - In Bearer, 8 in bearer/side, 2 top bearer & 2 back of bearer 16 - In Post, 8 either side	29	10
FFPSB10045	FF12045	12 - In Bearer, 8 in bearer/side, 2 top bearer & 2 back of bearer 16 - In Post, 8 either side	16.1	10
	FF14045		18.3	

## 6.5 ANGLE BRACKET

The angle bracket is used within the Fibreframe sub-frame system to join two profiles at a 90° angle.



FFAB10040

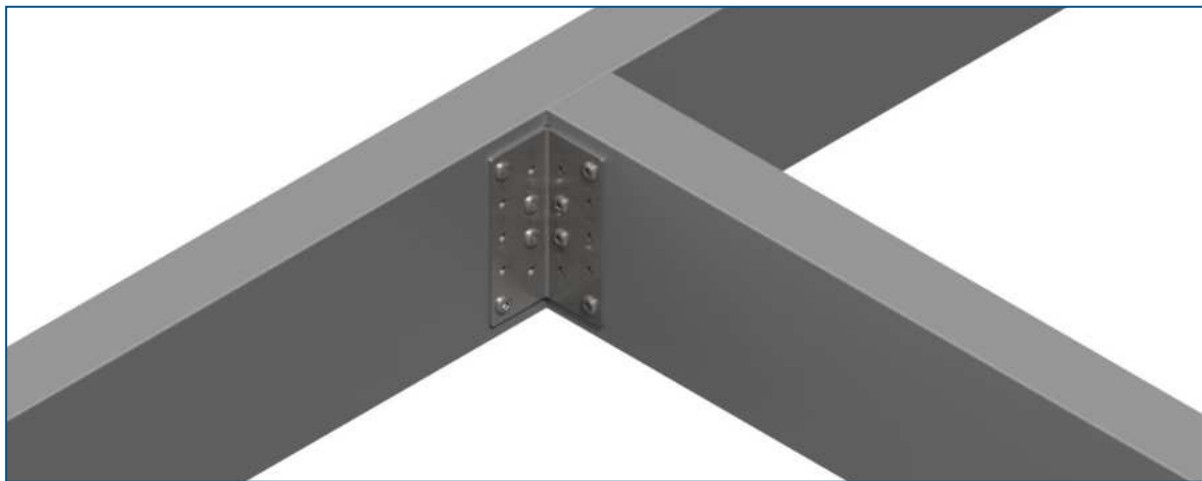

Bracket

Product	Material	Screw QTY	Thickness (mm)	Width (mm)	Height (mm)
FFAB10040	316ss	8- In Angle Bracket (4 either side)	2	40	100

# FIBRE FRAME

## BRACKETS, FASTENERS & END CAPS

14

### 6.6 PERGOLA BRACKET

In the Fibreframe sub-frame system, the pergola bracket is employed to connect a joist profile to a bearer profile at intersecting points.



FFPB01

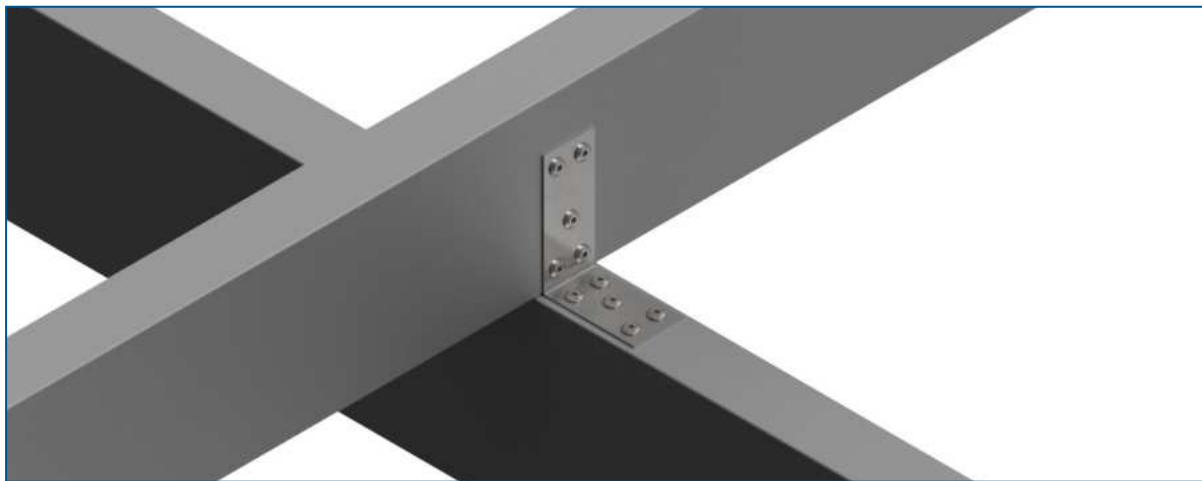

Bracket					
Product	Material	Screw QTY	Thickness (mm)	Width (mm)	Height (mm)
FFPB01	316ss	3 - In Bearer 3 - In Joist	1.5	36	85

## 6.7 SPLICE PLATES

The Fibre Frame splice plates serve to extend joist & bearers or enhance the load capacity of post top brackets.

### Extending Joists & Bearers:

Ideally the splice plate should be located on top of a post.

If placing the splice plate directly on top of the post isn't feasible, ensure the distance between the splice plate and the bearer remains less than a quarter of the joist & bearer span ( $\text{span}/4$ ). Refer to Diagram Below:

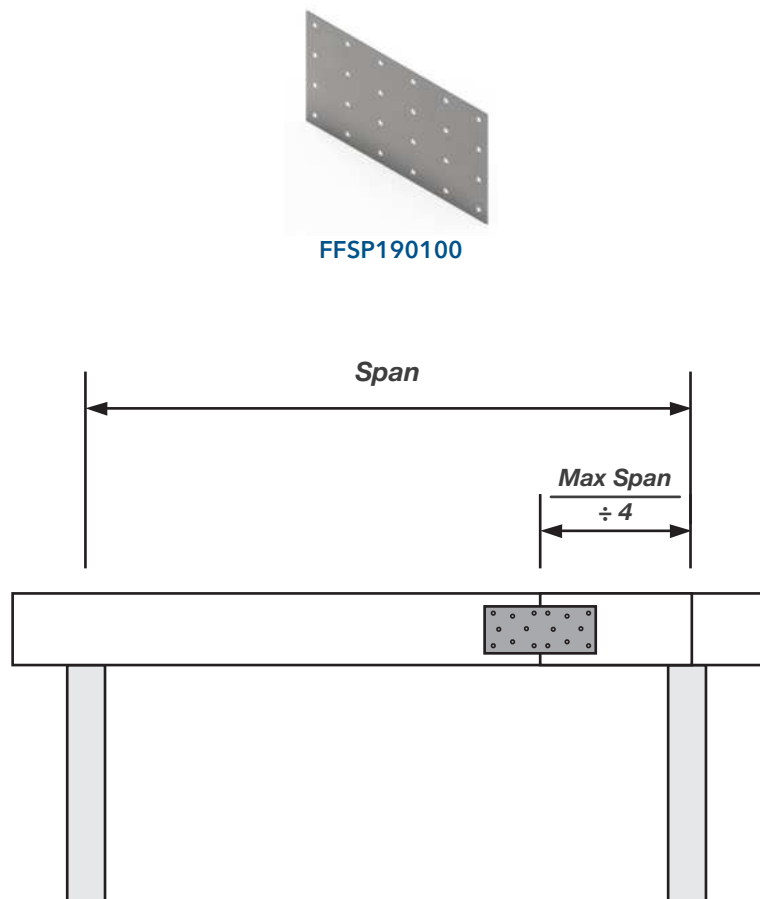

Figure: {Splice Plate Span Diagram}

All joists and bearers shall be joined together using splice plates on both sides of their webs.

# FIBRE FRAME

## BRACKETS, FASTENERS & END CAPS

16

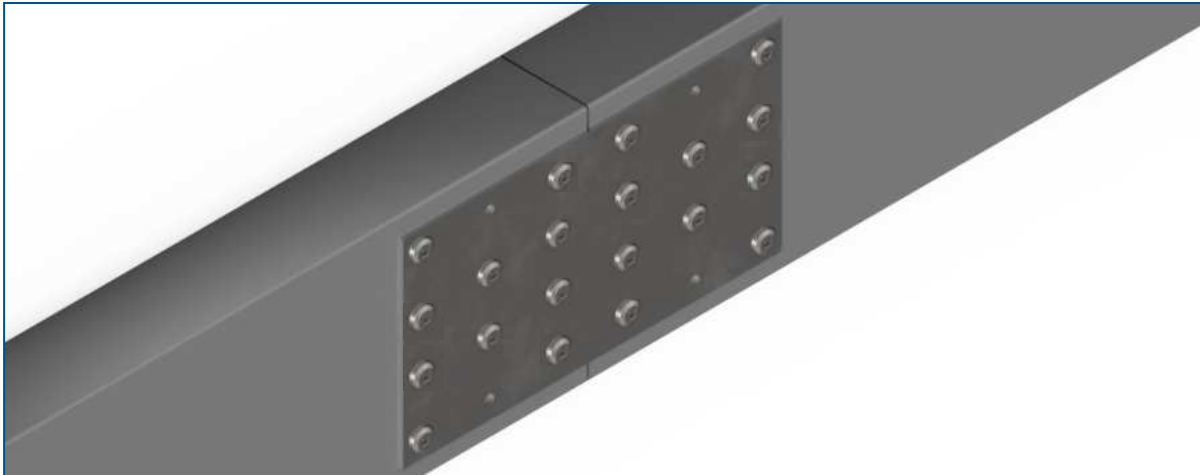

### Bracket

Product	Material	Thickness (mm)	Width (mm)	Height (mm)
FFSP190100	316ss	1.5	190	100

### Design Capacity of Splice Plate

Product	Member	Screw QTY	Splice Plate QTY	Design Capacity $\lambda\phi M_n$ (kNm)
FFSP190100	FF12045	20 - In Splice Plate (10 either side)	2 - One each side	1.4
FFSP190100	FF14045	20 - In Splice Plate (10 either side)	2 - One each side	1.8
FFSP190100	FF20050	20 - In Splice Plate (10 either side)	4 - 2 Each Side	3.6



## 6.8 POST SUPPORTS

The GRP Fibre Frame posts can be inserted into concrete foundations as detailed in the product brochure *GRP-BR-11 Fibre Frame*. Alternatively, post supports can be used if necessary. Although GRP Australia does not have specific post supports for the Fibre Frame system, the following or equivalent supports are considered suitable.

Post Supports		
Supplier	Product	Material
VueTrade	Bolt down Post Supports	Stainless Steel
VueTrade	Full Stirrup Post Supports	Stainless Steel
VueTrade	Cyclonic Pipe Supports	Stainless Steel

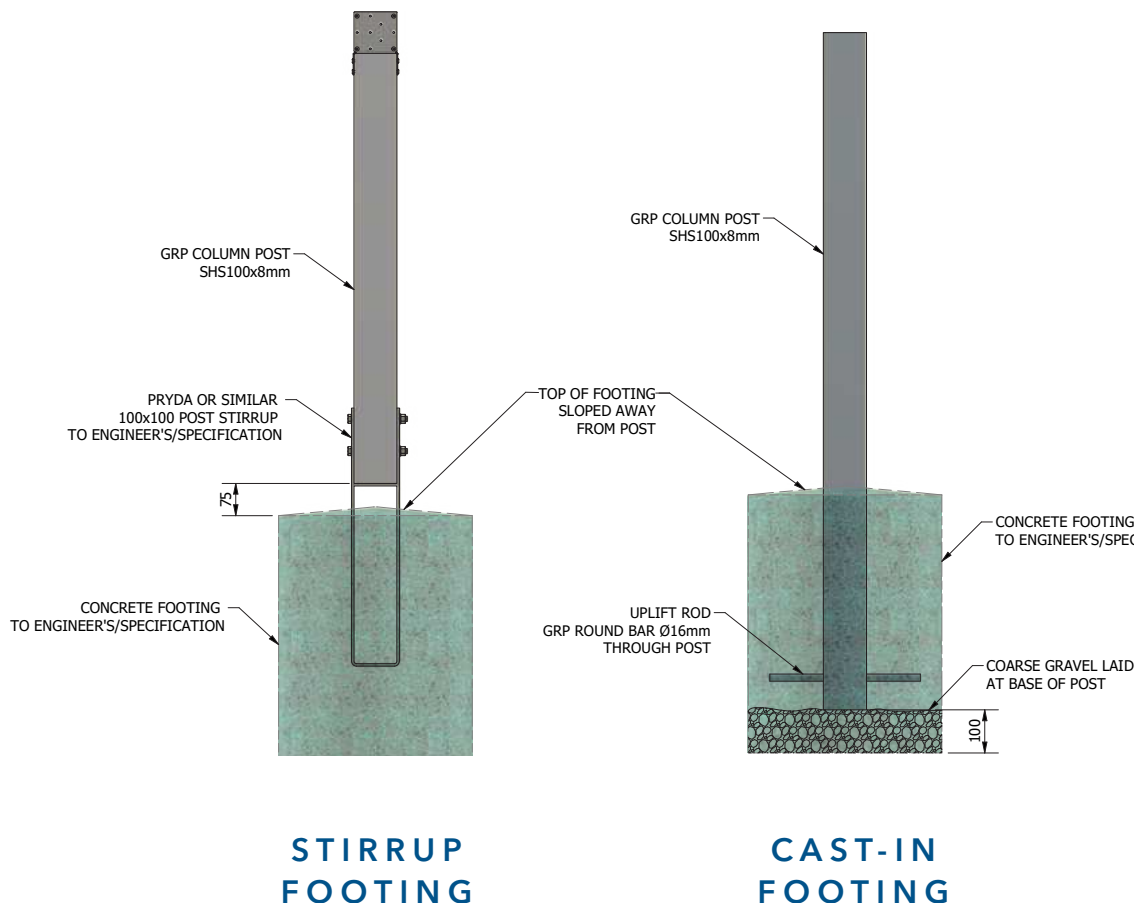

# FIBRE FRAME





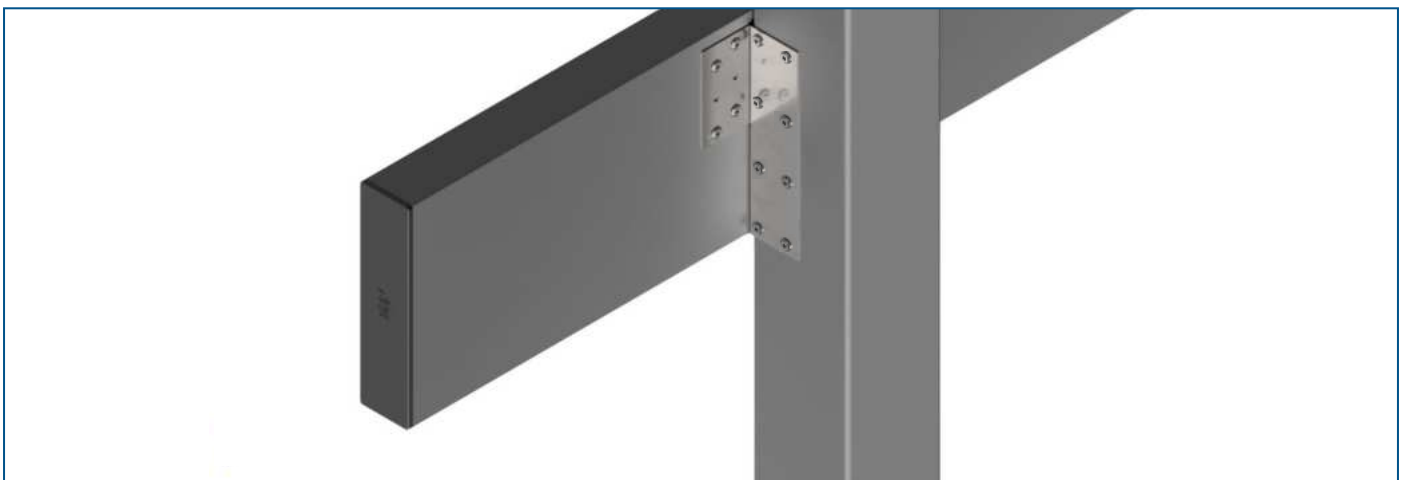

## BRACKETS, FASTENERS & END CAPS

18

### 6.9 END CAPS

End caps for joists, bearers, and posts are constructed from durable UV-resistant polypropylene and are available for all Fibre Frame joists, bearers, and posts.





PRODUCT CODE	FIBRE FRAME MEMBER	PRODUCT CODE	FIBRE FRAME MEMBER
 <b>EC9045</b>	FF9045	 <b>EC20050</b>	FF20050
 <b>EC12045</b>	FF12045	 <b>EC7676</b>	SHS76x6.4
 <b>EC14045</b>	FF14045	 <b>EC100100</b>	SHS100x8

## 6.10 ADJUSTABLE PEDESTALS

Heavy-duty, weather-resistant support for Fibre Frame joists & bearers; height adjustable for precise leveling on balconies, rooftops, and terraces.



PRODUCT CODE	HEIGHT RANGE	PRODUCT CODE	HEIGHT RANGE
 <b>GP50</b>	50 - 75mm	 <b>GP197</b>	197 - 281mm
 <b>GP74</b>	74 - 117mm	 <b>GP277</b>	277 - 281mm
 <b>GP117</b>	117 - 201mm	 <b>GPJH</b>	N / A
Screw QTY			
2 - In Pedestal Joist Holder 4 - In Bearer, 2 either side			



**GRP AUSTRALIA**

**L:** 25 Shannon Place, Virginia 4014

**E:** [sales@grpaustralia.com.au](mailto:sales@grpaustralia.com.au)

**P:** 07 3252 1244